

LuxxMaster® Wavelength Stabilized High Power 1 Watt Lasers for 938 nm. Based on proprietary volume Bragg grating™ (VBG™) technology for stabilizing and shaping the emission spectra of high power laser diodes.

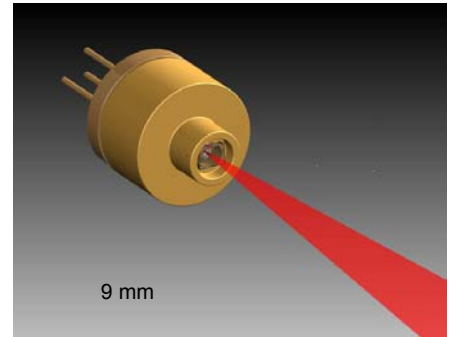
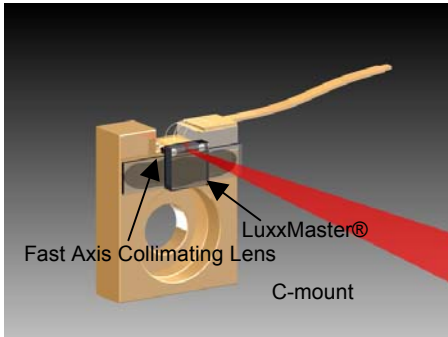

Performance

Advantage:

- ☐ $\lambda_c = \pm 0.5 \text{ nm}$
- ☐ Line Width <0.5nm (FWHM)
- ☐ Temp. Drift = 0.01 nm/°C
- ☐ > 80% Power locked

Advantages:

- ☐ Simple and compact
- ☐ Economical
- ☐ Lowers “Red Shift”
- ☐ Collimated Beam

Applications:

- ☐ DPSS Lasers
- ☐ Sensing
- ☐ Spectroscopy
- ☐ Medical
- ☐ Military

Optical and Operational Specifications

Parameter	Symbol	Condition	Min.	Typical	Max.	Units
Output Power	P_o	25°C		1		W
Center Wavelength	λ_c			938		nm
Center Wavelength Tolerance				± 0.3	± 0.5	nm
Operating Current	I_o	@ P_o		1.5		A
Forward Voltage	V_f	@ P_o	1.9		2.1	V
Threshold Current	I_{th}			200		mA
FWHM				<1.0		nm
Wavelength Drift Over Temperature				0.01		nm/°C
Slope Efficiency	SE	25°C		0.8		W/A
Horizontal Divergence Angle (//)	HFF	FWHM, P_o			10	degree
Vertical Divergence Angle (^)	VFF	FWHM, P_o		<1		degree
Laser Emitter Width	W_E			100		μm
Operating Temperature	T_o		10	25	40	°C
Storage Temperature	T_s		-40		+85	°C

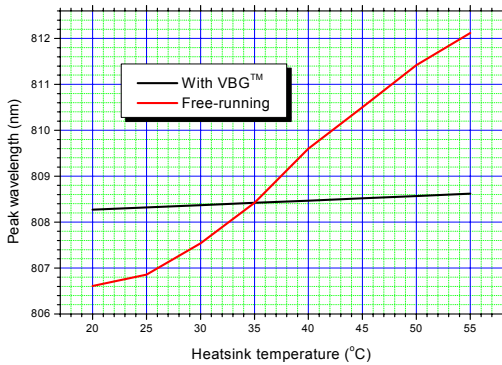

Wavelength versus Temperature

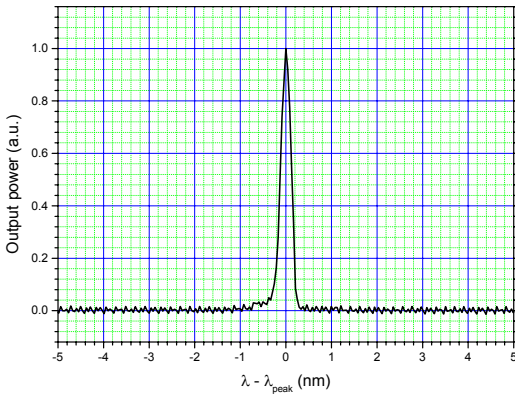

Typical Emission Spectrum

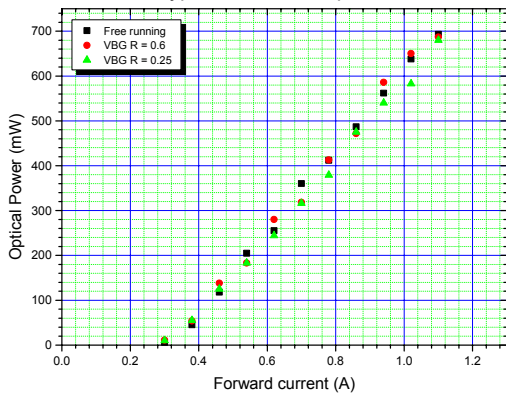

Power versus Forward Current

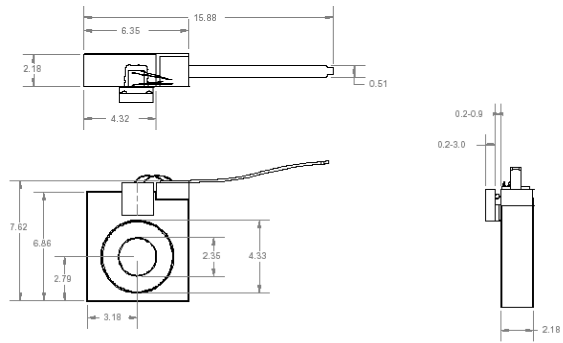

C-Mount Package

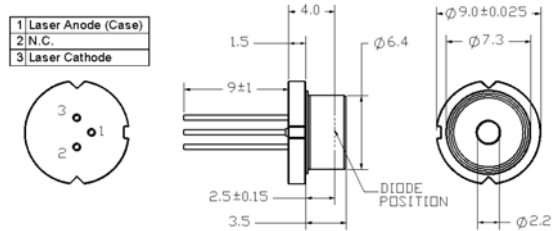

9 mm Package

Part Number System:

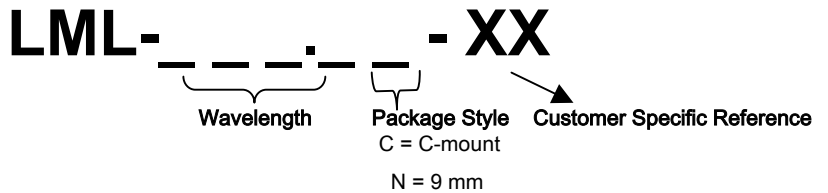

Example: LML-808.7C-XX This is a LuxxMaster® Laser with a center wavelength of 808.7 nm in a C-mount package.